

UP TO 3 HOURS

VISION LITE - THRUBOLT™ SERIES - VLF

Standard, multi-purpose, thru-bolted square profile vision lite that maximizes the exposed glazing visible light in a door. VLF models are for standard door and glazing thickness.

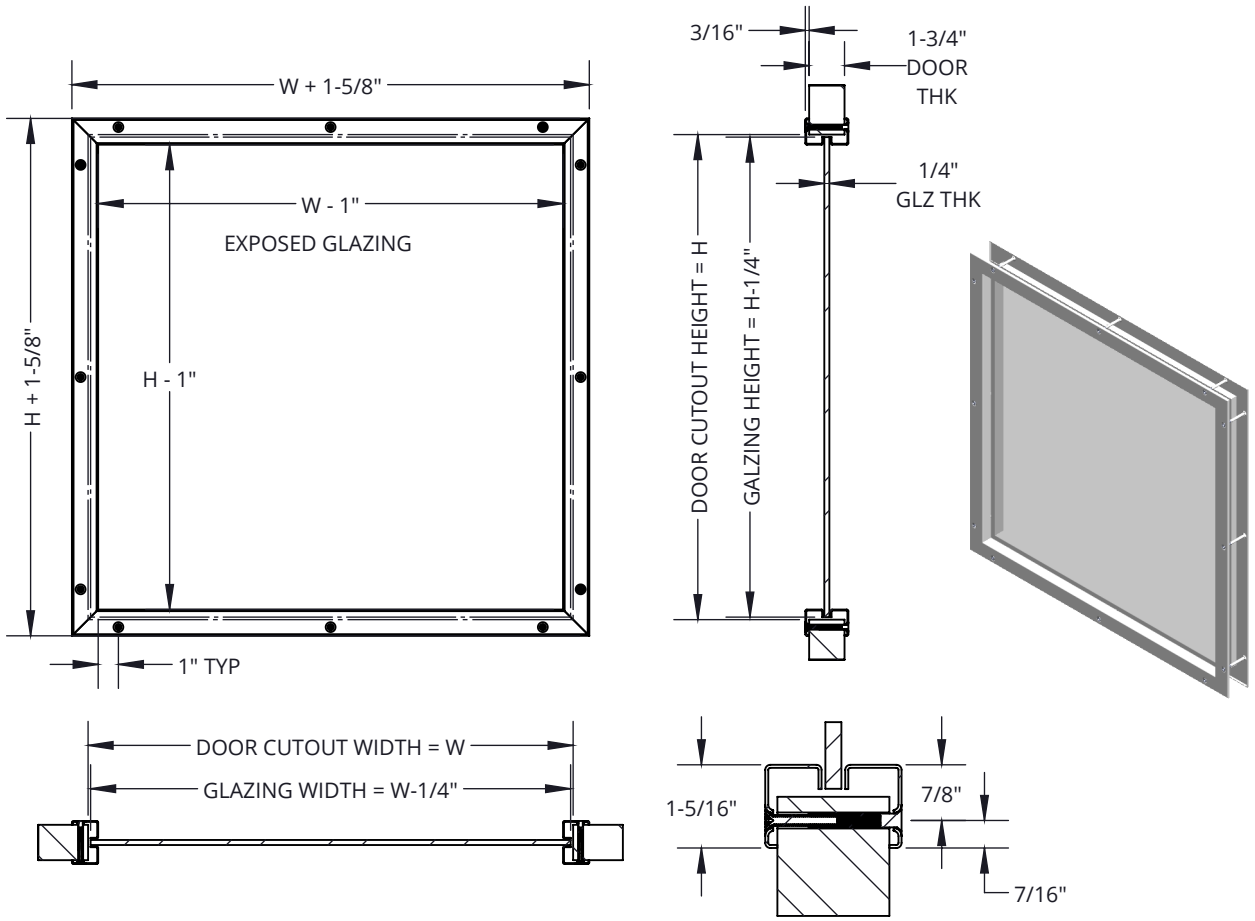

SPECIFICATIONS

Application:

For standard door thickness 1-3/4" and standard glazing thickness 3/16" - 1/4".

For standard door thickness 1-3/4" and non-standard glazing thickness of 5/16" - 1-1/16" see VLFIG.

For non-standard door thickness 1" - 3" and non-standard glazing thickness of 3/16" - 1-1/16" see VLFIG.

Frame Material: 18 gauge cold rolled steel

Standard Finish: Mineral bronze powder coat

Fasteners: #8 x 32 Flathead Phillips head thru-bolt with blank heads on one side to match finish

Size:

Minimum: 4" x 4"

Maximum: Maximum size fire-rating is determined by glass listing (for doors) and door manufacturer's listing
Door Cutout = Order Size (W x H)

Glazing Size = Order Size minus 1/4" (W - 1/4" x H - 1/4")

Exposed Glazing = Order Size minus 1" (W - 1" x H - 1")

FIRE RATINGS:

UL listed and labeled/stamped to ANSI/UL 10B, ANSI/UL 10C and CAN/ULC S104 when properly installed in rated and approved door. Ratings up to 180 minutes can be achieved depending on exposed glazing size and area.

OPTIONS:

Materials: 18 gauge 304 Stainless steel, galvanized steel, zinc-plated steel

Mullions: 1" x 5/8" welded-on, formed mullions for a divided lite look that uses one (1) pane of glass

PAKs: Vision lite, glazing & glazing tape combined

Compatible Air Louvers Glazing:

Fire-Rated: PPF, FL, FGL, WS

Non-Rated: TEMP

Other: Torx screws

TAPE WHEN SOLD SEPARATELY

Qty	Model	Description Dimensions
	GTAPE 200B	Standard glazing tape 1/16" 1/16" thick x 3/8" wide x 200 ft
	FGS3000S90	Intumescent tape for wired glass 5/64" thick x 7/16" wide x 16 ft

Refer to glazing tape submittal for more information

Interpretation of fire and building codes may vary.
Consult with the local authority having jurisdiction (AHJ) to determine appropriate standards.



AIR LOUVERS

9702 Newton Avenue S, Bloomington, MN 55431

800-554-6077

sales@activarcpg.com











www.activarcpg.com

Distributor:		Project:	
Contractor:		Approved By:	
Date:		Architect:	
Scale: N/A	Page 1 of 2	Item#:	

MADE-TO-ORDER THRUBOLT VISION LITE - EXAMPLE: VLF 1218SI

QTY	MODEL	MATERIAL	MULLIONS OPTIONS	WIDTH	HEIGHT	FINISH	PAK GLAZING OPTIONS	OPTIONS
	VLF	Cold Rolled Steel - Std.	None			B Bronze - Std.	None	None
		S Stainless Steel	A (1 Column)			AB AMS Beige	FL PAK 3/16" Firelite NT	-T Torx Screw
		G Galvannealed Steel	B (2 Column)			SB SC Beige	PPF PAK 3/16" Pyran Platinum F	
		E Zinc-Plated Steel	C (3 Column)			S Sand	FGL PAK 1/4" Fireglass 20	
						G Gray	TEMP PAK 1/4" Tempered	
						SI Silver	WS PAK 1/4" Wireshield	
						W White	Other PAK - specify below:	
						BK Black		
						FB Flat Black		
						BA Brass		
						Other - specify below:		





MULLIONS

	2	3	4	5
A	 A2 Min: 6" x 6"	 A3 Min: 6" x 7"	 A4 Min: 6" x 9"	 A5 Min: 6" x 11"
B	 B2 Min: 6" x 6"	 B3 Min: 6" x 7"	 B4 Min: 6" x 9"	 B5 Min: 6" x 11"
C	--	 C3 Min: 7" x 7"	 C4 Min: 7" x 9"	 C5 Min: 7" x 11"

MULLION OPTIONS

1" x 5/8" Standard Mullion
1/2" x 1/2" Optional Size
1/2" x 3/4" Optional Size

Min. Lite Size for Mullions varies with columns and rows, see chart.

B Bronze - Std.	
AB AMS Beige	
SB SC Beige	
S Sand	
G Gray	
SI Silver	
W White	
BK Black	
FB Flat Black	
BA Brass	
Other - specify below:	



VLF 1212B