

UP TO 3 HOURS

VISION LITE - EZLINE™ SERIES - VLFEZIG

Self-attaching beveled vision lite with single side fasteners for doors. VLFEZIG models are for non-standard door and glazing thickness.

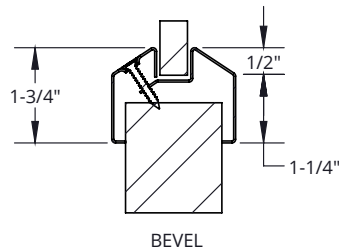
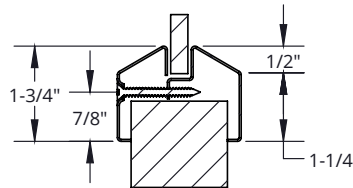
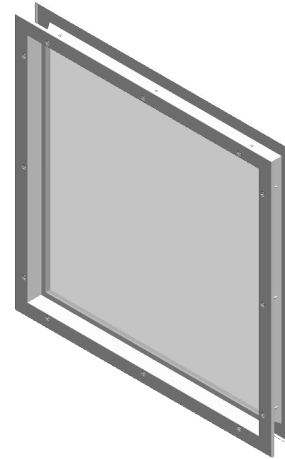
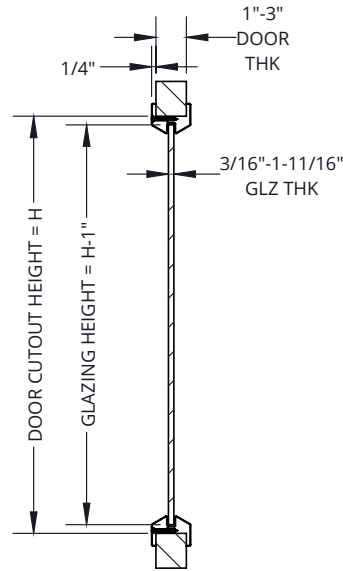
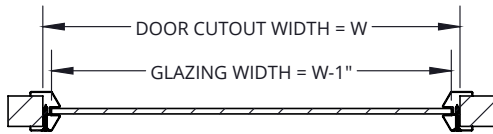
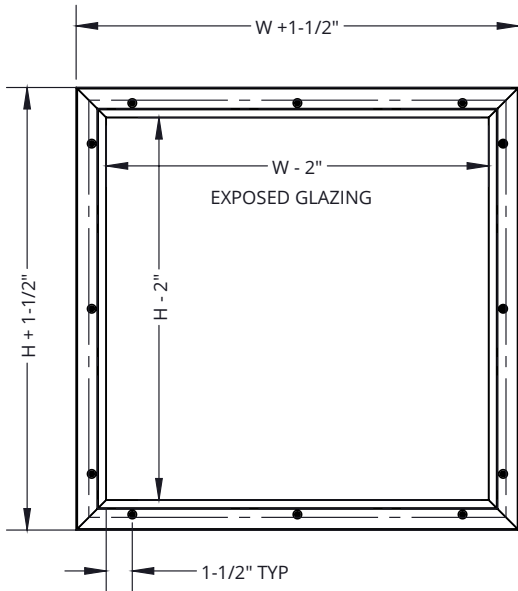

SPECIFICATIONS

Application:

For standard door thickness 1-3/4" and non-standard glazing thickness 5/16" - 1-11/16".
 For non-standard door thickness 1" - 3" and glazing thickness of 3/16" - 1-11/16".
 Must specify both on Made-to-Order table.
 For standard door thickness 1-3/4" and standard glazing thickness of 3/16" - 1/4" see VLFEZ.

Frame Design:

Holes through bevel - Door Thickness 1" - 1-3/4" AND door thickness minus glazing thickness $\geq 3/4$ ".
Holes through face - Door Thickness 1" - 1-3/4" AND door thickness minus glazing thickness $< 3/4$ " OR door thickness $> 1-3/4$ " AND any glazing thickness 3/16" - 1-11/16"

Frame Material: 20 gauge cold rolled steel

Standard Finish: Mineral bronze powder coat

Fasteners: #8 x 1" Flathead Phillips screws to match finish

Size:

Minimum: 4" x 4"

Maximum: Maximum size fire-rating is determined by glass listing (for doors) and door manufacturer's listing
 Door Cutout = Order Size (W x H)

Glazing Size = Order Size minus 1" (W - 1" x H - 1")

Exposed Glazing = Order Size minus 2" (W - 2" x H - 2")

FIRE RATINGS:

UL listed and labeled/stamped to ANSI/UL 10B, ANSI/UL 10C and CAN/ULC S104 when properly installed in rated and approved door. Ratings up to 180 minutes can be achieved depending on exposed glazing size and area.

OPTIONS:

Materials: 20 gauge 304 Stainless steel, galvaneal steel, zinc-plated steel

Mullions: 1" x 5/8" welded-on, formed mullions for a divided lite look that uses one (1) pane of glass

PAKs: Vision lite, glazing & glazing tape combined

Compatible Air Louvers Glazing:

Fire-Rated: PPF, FL, FLP, FGL, WS (also compatible with non 1-3/4" door)

Non-Rated: TEMP, ARM1, ARM2, ARM3, BRG1, BRG2

See VLFIG submittal

Other: Torx screws

TAPE WHEN SOLD SEPARATELY

Qty	Model	Description Dimensions
	GTAPE 200B	Standard glazing tape 1/16" 1/16" thick x 3/8" wide x 200 ft
	FGS3000S90	Intumescent tape for wired glass 5/64" thick x 7/16" wide x 16 ft

Refer to glazing tape submittal for more information

Interpretation of fire and building codes may vary. Consult with the local authority having jurisdiction (AHJ) to determine appropriate standards.



AIR LOUVERS

9702 Newton Avenue S, Bloomington, MN 55431

800-554-6077

sales@activarcpg.com











www.activarcpg.com

Distributor:		Project:	
Contractor:		Approved By:	
Date:		Architect:	
Scale: N/A	Page 1 of 2	Item#:	

MADE-TO-ORDER EZLINE™ VISION LITE - EXAMPLE: VLFEZIG 2432B 01

QTY	MODEL	MATERIAL	MULLIONS OPTIONS	WIDTH	HEIGHT	FINISH	GLAZING THICKNESS*	DOOR THICKNESS	PAK GLAZING OPTIONS	OPTIONS
	VLFEZIG	Cold Rolled Steel - Std.	Columns (choose one)			B Bronze - Std.	516 5/16"	1-3/4" Std.	None	None
		S Stainless Steel	None			AB AMS Beige	38 3/8"	01D 1"	FL PAK 3/16" Firelite NT	LL Lead Line*
		G Galvannealed Steel	A (1 Column)			SB SC Beige	12 1/2"	0138D 1-3/8"	PPF PAK 3/16" Pyran Platinum F	-T Torx Screw
		E Zinc-Plated Steel	B (2 Column)			S Sand	01 1"	03D 3"	FGL PAK 1/4" Fireglass 20	*See separate VLFEZIG Lead Line submittal
			C (3 Column)			G Gray	Other (specify size):	Other (specify size):	TEMP PAK 1/4" Non-Rated Tempered	
			ROWS (choose one)			SI Silver			WS PAK 1/4" WireShield	
			None			W White			FLP PAK 5/16" Firelite Plus	
			2 (2 Rows)			BK Black			ARM1 PAK 13/16" ArmrShield 1	
			3 (3 Rows)			FB Flat Black			ARM2 PAK 1-1/16" ArmrShield 2	
			4 (4 Rows)			BA Brass			BRG1 PAK 1-3/16" BRG 1	
			5 (5 Rows)			Other - specify below:			ARM3 PAK 1-5/16" ArmrShield 3	
									BRG2 PAK 1-1/2" BRG 2	
									Other PAK - specify below:	

MULLIONS

	2	3	4	5
A	 A2 Min: 6" x 6"	 A3 Min: 6" x 7"	 A4 Min: 6" x 9"	 A5 Min: 6" x 11"
B	 B2 Min: 6" x 6"	 B3 Min: 6" x 7"	 B4 Min: 6" x 9"	 B5 Min: 6" x 11"
C	--	 C3 Min: 7" x 7"	 C4 Min: 7" x 9"	 C5 Min: 7" x 11"

MULLION OPTIONS

1" x 5/8" Standard Mullion
1/2" x 1/2" Optional Size
1/2" x 3/4" Optional Size

Min. Lite Size for Mullions varies with columns and rows, see chart.

*Not needed for PAKs